

DAT Bergbautechnik GmbH

Am Schornacker 61
D-46485 Wesel

Phone +49 (0)281 2067 170 info@dat-bergbau.de
Fax +49 (0)281 2067 1760 www.dat-bergbau.de

Control systems for hydraulic shield

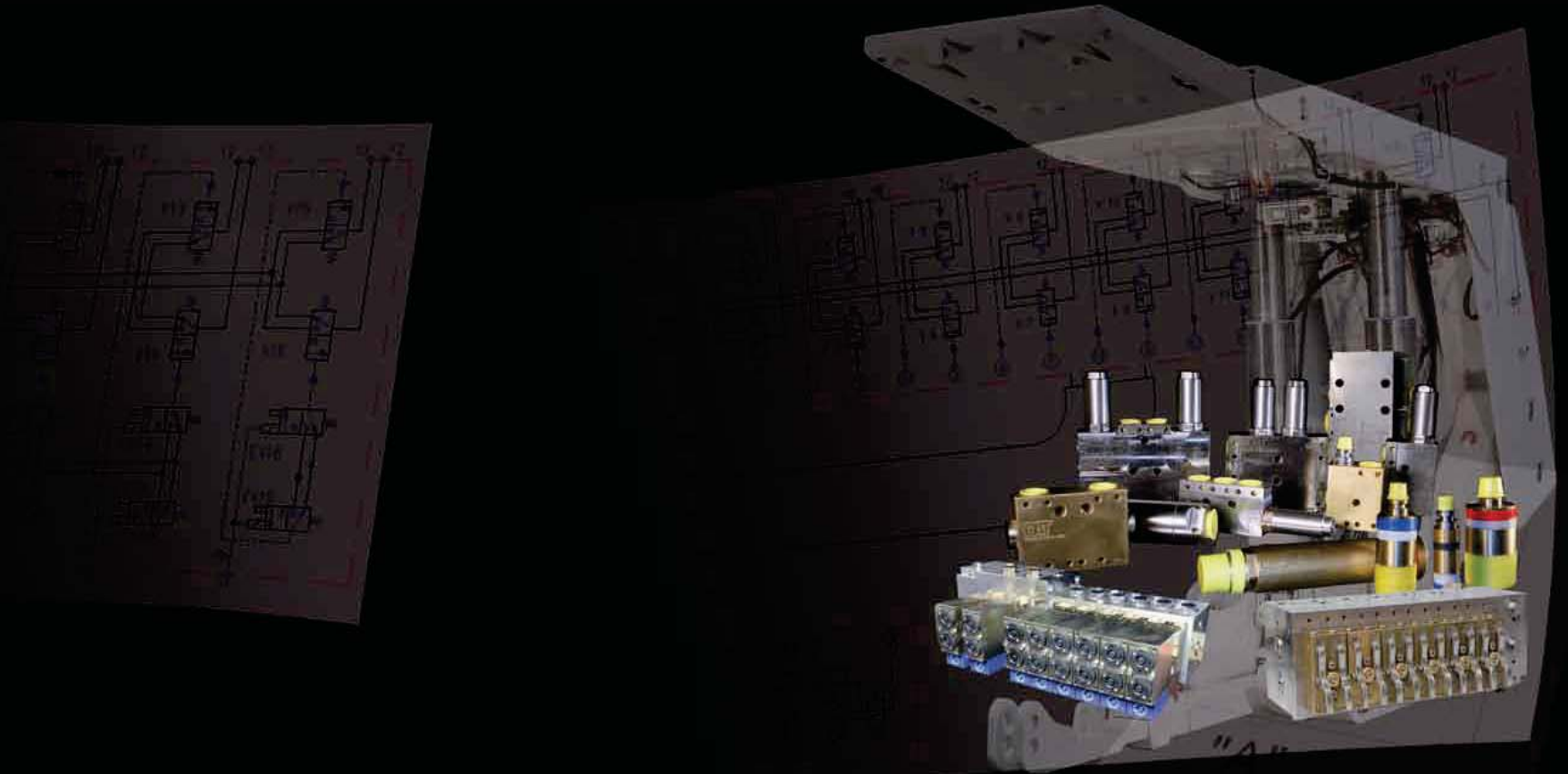

DAT Bergbautechnik GmbH

DAT Bergbautechnik GmbH is synonymous with innovative and state-of-the-art technology including the technical advice for their customers and the service offerings necessary for such complex installations.

DAT has the necessary system knowledge as well as the most experienced specialists to work out solutions quickly and service our customers worldwide. DAT additionally calls in companies specializing in certain components and component groups who help instantly and in an uncomplicated manner whenever problems occur.

Our hallmarks are state-of-the-art mining technology, quality, on-time delivery and an excellent service which all contribute to your success at the mines. DAT supports its customers up to the point when the installations are taken into operation and of course offers an optimum after-sales service. The customers decide whether they want support when the need arises or continuous support the details of which are laid down in a service contract.

In addition to brand-new systems and machinery DAT also offers used, optimally refurbished mining equipment.



The most modern CNC manufacturing technology in use



CAD workstation in construction department

DAT Bergbautechnik GmbH located in Wesel



Control technology

DAT supplies customer-specific control systems which distinguish themselves for an easy handling as well as an easy maintenance. All water-bearing components are made of stainless steel, brass or ceramics. The control systems are designed as to be used in longwalls with new shield support as well as with used shield support being a cost-efficient alternative.



Valve technology

DAT Bergbautechnik preferential uses valves in cartridge construction type which characterizes itself by an uncomplicated replacement in case of repair. Unscrew the damaged cartridges; screw in the new cartridge, the valve can be used again immediately.

Valve sealings are available in steel/steel, steel/ceramic as well as steel combined with high-strength plastic material.



Check valves

The cartridges can be delivered in very different housings and combinations. Our scope of delivery includes inexpensive standard valves as well as customized valves. Challenge us.



Other valves

DAT Bergbautechnik GmbH also supplies all additional valves which are necessary for the control of the shield support as for example flip-flop valves, in-line filters, in-line check valves, isolating valves, safety circuit throttles, etc.



Pressure relief valves

The pressure relief valves form an important part in hydraulic systems. Using this valve, the maximum hydraulic pressure can be limited in order to protect the hydraulic system from too high pressure and damages. If the pressure in the system exceeds a desired (adjusted) value, this valve enables a discharge of the hydraulic fluid.

DAT Bergbautechnik supplies directly operated as well as pilot operated pressure relief valves for different applications in all kind of performance classes.



Construction and development

Our plants and components have to be always individual tailored, according to the requirements of our customers. Therefore our day-to-day work is focused on development and construction. From the draft to the final documentation our technicians use for the development of customer-specific and plant-specific solutions the most modern CAD systems.

Furthermore we work in close cooperation with specialists with practical experience in the construction of control technologies. The long time experience they gained from the day-to-day work in the underground mines is also evaluated and used for the development of new products. In this way new products are developed, which are characterized by their simple handling and maintainability, as well as by long useful life.

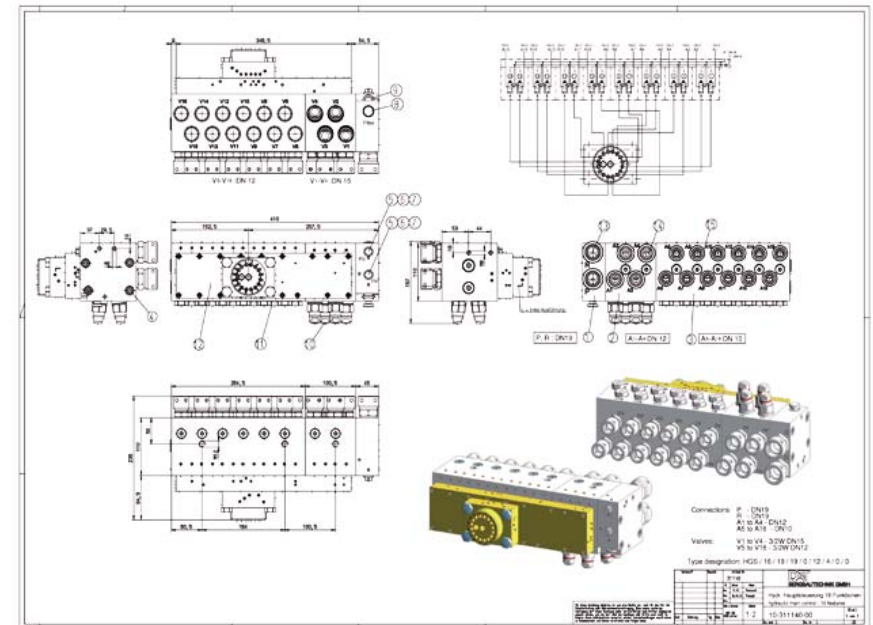
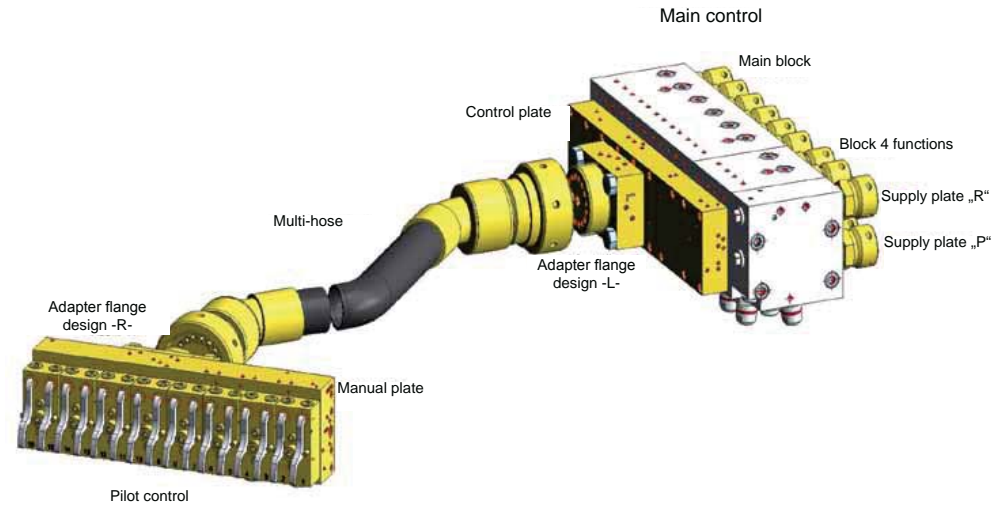
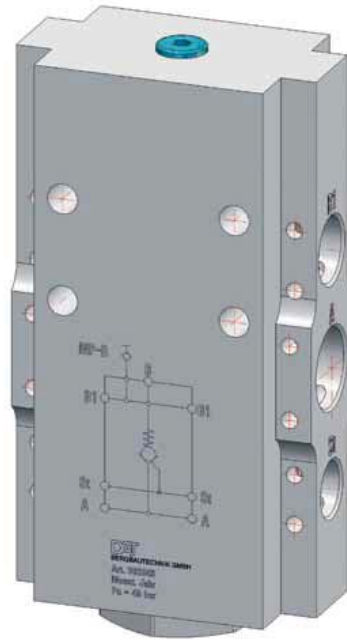

Manufacture

Our manufacturing is characterized by its accurate construction based on the most modern CAD technology and careful production of the components by our suppliers. Our suppliers are certified and international active companies with high level of expertise. High quality products are produced in continuous contact and under control carried out by our specialists.

All water-bearing components are made of stainless steel, brass or ceramics.

The final assembly and checking of the products take place in our production halls in Wesel.

All these guarantee the efficiency of our demanding and individual solutions.

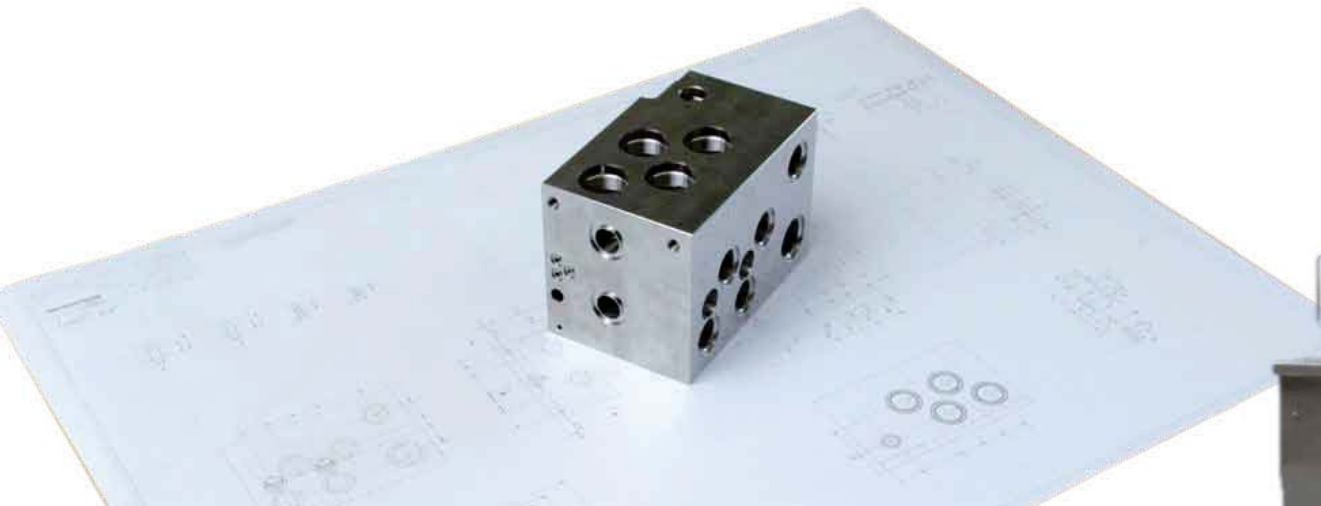
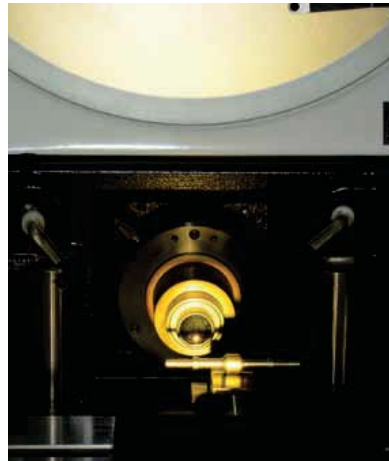

Assembly and quality check

Each component determines the lifetime and the efficiency of the complete hydraulic plant. High-quality and reliable components are an absolute prerequisite in the mining sector. Therefore all components undergo a functional check and quality inspection before and after assembly.

Specially trained professionals check the proper function of our control systems and valves using special technical equipment, such as for instance our mobile hydraulic testing bench.



As result we have long-lasting hydraulic systems, that work reliably and precisely under extreme conditions.

We stand for high quality products!

Our quality management system is certified according to EN ISO 9001:2008.

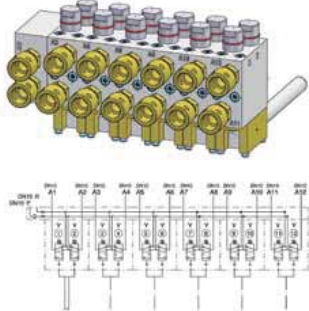
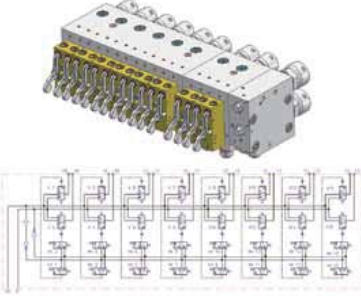

Control technology





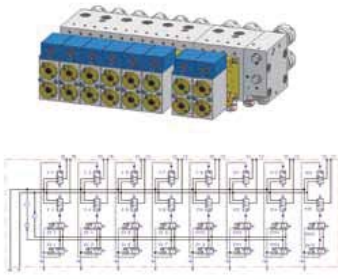

	<p>Manual control system</p> <p>Design: Pilot direct-activated Dimensions*: H 110 mm x D 110mm x length depending on the design Material: Stainless steel / brass / all valve seats steel or steel ceramic Testing pressure: 500 bar Nominal pressure: 350 bar Connections: High-pressure: DN10, DN12, Return line: DN10, DN12, Appliances: DN10 or DN12 Functions: Depending on the design between 2 and 22</p>
	<p>Pilot control system</p> <p>Design: Pilot direct-activated Dimensions*: H 110 mm x D 110 mm x length depending on the design Material: Stainless steel / brass / all valve seats steel or steel ceramic Testing pressure: 500 bar Nominal pressure: 350 bar Connections: High-pressure: DN 19 Return line: DN 19 Appliances: DN 12 and/or DN 10 Functions: Depending on the design between 4 and 22</p>
	<p>Multi-hose control systems, split-type</p> <p>Pilot control unit Design: Pilot activated main valves via multi-hose DN 3 Dimensions*: H 98 mm x D 40 mm x length depending on the design Material: Stainless steel / brass / all valve seats steel or steel ceramic Testing pressure: 500 bar Nominal pressure: 350 bar</p> <p>Main control unit Dimensions*: H 115 mm x D 125 mm x length depending on the design Material: Stainless steel / brass / all valve seats steel or steel ceramic Testing pressure: 500 bar Nominal pressure: 350 bar Connections: Configurable according to customer's requirements Functions: Depending on the design between 8 and 22</p>

*Changes of construction modifications remain open

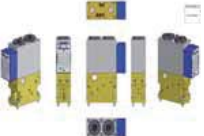
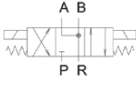

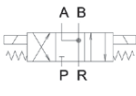
Control technology

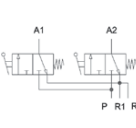
	<p>Electro-hydraulic control system</p> <p>Design: Pilot-activated main valves via solenoid valve Dimensions*: H 110 mm x D 125 mm x L 410 mm Material: Stainless steel / brass / all valve seats steel or steel ceramic Testing pressure: 500 bar Nominal pressure: 350 bar Connections: High-pressure: DN 25 Return line: DN 25 Appliances: DN 19/ DN 12 / DN 10 Functions: Depending on the design between 4 and 22</p>
---	--

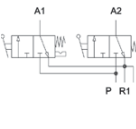
Valve technology / Pilot valves

		<p>4/3 way valve NG2 iM DAT 01</p> <p>Dimensions*: H 144,5 mm x W 40 mm x D 111 mm Testing pressure: 480 bar Nominal pressure: 320 bar Connections: flange plate type A</p>
		<p>4/3 way valve NG2 iM DAT 02</p> <p>Dimensions*: H 145 mm x W 40 mm x D 121 mm Testing pressure: 480 bar Nominal pressure: 320 bar Connections: flange plate type B</p>
		<p>4/3 hand lever valve NG3 unlocked</p> <p>Dimensions*: H 84 mm x W 40 mm x D 62 mm Testing pressure: 480 bar Nominal pressure: 320 bar Connections: flange plate type A</p>
		<p>4/3 hand lever valve NG3 right locked</p> <p>Dimensions*: H 84 mm x W 40 mm x D 67 mm Testing pressure: 480 bar Nominal pressure: 320 bar Connections: flange plate type A</p>

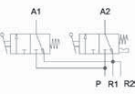
Valve technology / Pilot valves

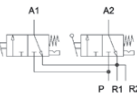





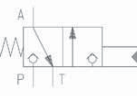

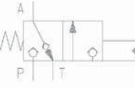

		<p>4/3 hand lever valve NG3 left locked</p> <p>Dimensions*: H 84 mm x W 40 mm x D 67 mm Testing pressure: 480 bar Nominal pressure: 320 bar Connections: flange plate type A</p>
		<p>4/3 hand lever valve NG3 double locked</p> <p>Dimensions*: H 84 mm x W 40 mm x D 67 mm Testing pressure: 480 bar Nominal pressure: 320 bar Connections: flange plate type A</p>

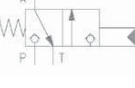

Valve technology / Valve cartridges

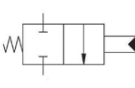
		<p>3/2 way cartridge DN 12</p> <p>Test pressure: 500 bar Pressure range: up to 400 bar Nominal size: 12</p>
---	---	--



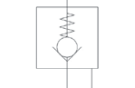

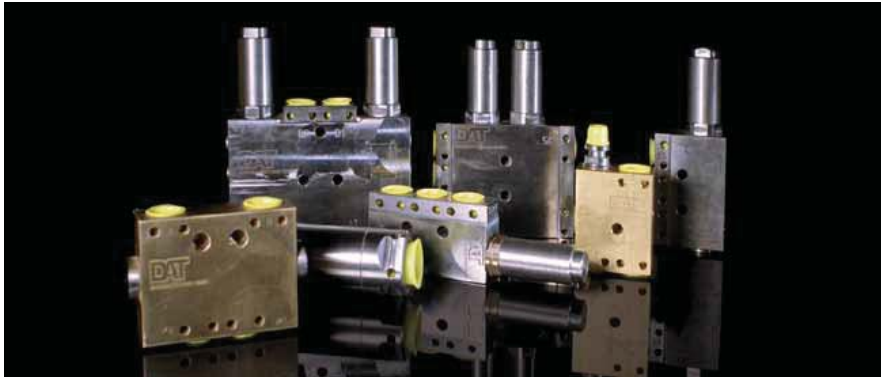

Valve technology / Valve cartridges

		<p>3/2 way cartridge DN 12 +RV</p> <p>Test pressure: 500 bar Pressure range: up to 400 bar Nominal size: 12</p>
		<p>3/2 way cartridge DN 15</p> <p>Test pressure: 500 bar Pressure range: up to 400 bar Nominal size: 15</p>
		<p>3/2 way cartridge DN 20</p> <p>Test pressure: 500 bar Pressure range: up to 400 bar Nominal size: 20</p>
		<p>Water spray valve cartridge DN 10</p> <p>Test pressure: 500 bar Pressure range: up to 400 bar Nominal size: 10</p>
		<p>Pilot-operated check valve cartridge</p> <p>Test pressure: 500 bar Pressure range: up to 400 bar Delocable pressure: 35 bar or 65 bar Nominal size: 10</p>
		<p>Pilot-operated check valve cartridge independent of the load pressure</p> <p>Test pressure: 500 bar Pressure range: up to 400 bar Delocable pressure: 60 bar or 90 bar Nominal size: 12</p>

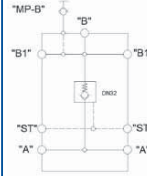
*Changes of construction modifications remain open

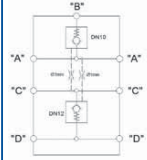

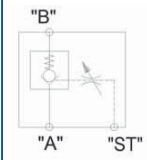

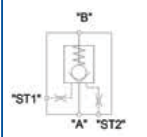



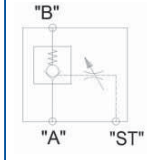

Valve technology / Pilot-operated valves

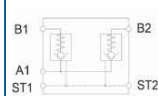

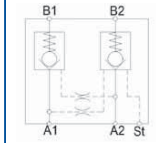

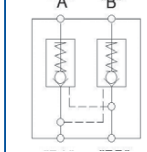
		Pilot-operated check valve DN32/025 Dimensions*: H 208 mm x D 65 mm x L 126 mm Test pressure: 500 bar Nominal pressure: 350 bar Delocable pressure: 80 bar Connections: DN 10 / DN 25 / DN 12 or DN 10 / DN 19 / DN 12 or according to the customers' request until DN 32
		Pilot-operated double check valve DN 12/10 Dimensions*: H 288 mm x D 64 mm x L 95 mm Test pressure: 500 bar Nominal pressure: 350 bar Delocable pressure: Piston area: 80 bar, ring area: 35 bar Connections: DN 19 / DN 12 / DN 10 or DN 12 / DN 12 / DN 10
		Pilot-operated check valve DN 10 Dimensions*: H 171 mm x D 32 mm x L 60 mm Test pressure: 500 bar Nominal pressure: 350 bar Delocable pressure: 35 bar or 65 bar Connections: DN 10 / 10 / 10
		Pilot-operated check valve DN 10 with additional control piston DN 10 Dimensions*: H 220 mm x D 32 mm x L 60 mm Test pressure: 500 bar Nominal pressure: 350 bar Delocable pressure: 35 bar or 65 bar Connections: DN 10 / DN 10 / DN 10 / DN 10

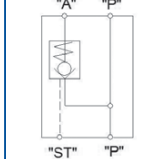
*Changes of construction modifications remain open

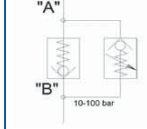



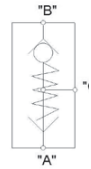

Valve technology / Pilot-operated valves

		Pilot-operated check valve DN 12 Dimensions*: H 163,5 mm x D 36 mm x L 63 mm Test pressure: 500 bar Nominal pressure: 350 bar Delocable pressure: 65 bar or 95 bar Connections: DN 12 / DN 12 / DN 10 or DN 10 / DN 10 / DN 10 or according to the customers' request
		Pilot-operated double check valve DN 10 Dimensions*: H 172 mm x D 32 mm x L 123 mm Test pressure: 500 bar Nominal pressure: 350 bar Delocable pressure: 65 bar Connections: DN 10 / DN 10 / DN 10 / DN 10
		Pilot-operated check valve DN 10 with additional control piston Dimensions*: H 220 mm x D 32 mm x L 123 mm Test pressure: 500 bar Nominal pressure: 350 bar Delocable pressure: 65 bar Connections: DN 10 / DN 10 / DN 10 / DN 10
		Pilot-operated double check valve DN 10 Dimensions*: H 80 mm x D 28 mm x L 114 mm Test pressure: 500 bar Nominal pressure: 350 bar Transmission ratio: 1:4,7 Connections: DN 10 / DN 10 / DN 10 / DN 10
		Pilot-operated check valve DN 10 Dimensions*: H 110 mm x D 28 mm x L 60 mm Test pressure: 500 bar Nominal pressure: 350 bar Transmission ratio: 1:4/1:8/1:12 Connections: DN 10 / DN 10 / DN 10 / DN 10
		Counterbalance (pre-load) valve DN 10 (adjustable from 30 until 110 bar) Dimensions*: H 60 mm x D 30 mm x L 217 mm Test pressure: 500 bar Nominal pressure: 350 bar Pre-load pressure: 30 bar to 110 bar Connections: DN 10 / DN 10

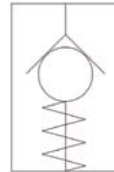
Valve technology / In-line valves

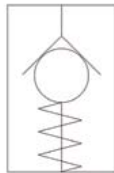

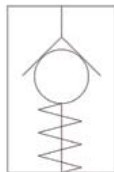





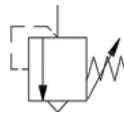

		<p>Start choke DN 12 or DN 19</p> <p>Dimensions*: L = 170 mm Ø= 48 mm Test pressure: 600 bar Nominal pressure: 400 bar Connections: DN 12 or DN 19</p>
		<p>Spring-loaded flip-flop valve DN 10</p> <p>Dimensions*: H 136 mm x D 40 mm x L 58 mm Test pressure: 525 bar Nominal pressure: 350 bar Connections: DN 10</p>

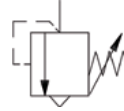
In-line check valves DN10 - DN51

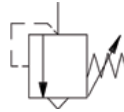
		<p>In-line check valve DN 10</p> <p>Dimensions*: L = 95 mm Ø= 32 mm Test pressure: 525 bar Nominal pressure: 350 bar Connections: DN 10</p>
		<p>In-line check valve DN25</p> <p>Dimensions*: L = 125 mm Ø= 55 mm Test pressure: 525 bar Nominal pressure: 350 bar Connections: DN25</p>
		<p>In-line check valve DN31 female/ male</p> <p>Dimensions*: L = 181 mm Ø = 65 mm Test pressure: 525 bar Nominal pressure: 350 bar Connections: DN31</p>
		<p>In-line check valve 3/8"</p> <p>Dimensions*: L = 70mm Ø = 30 mm Test pressure: 525 bar Nominal pressure: 350 bar Connections: special connection</p>

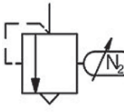

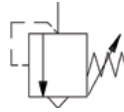

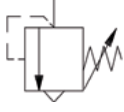
*Changes of construction modifications remain open

Valve technology / Pressure relief valves

		<p>Pressure relief valve DBV 125</p> <p>Dimensions*: L = 110 mm Ø= 27 mm Pressure range: 200 – 500 bar Rate of flow: 125 l/min Connections: DN 10</p>
		<p>Pressure relief valve DBV 250</p> <p>Dimensions*: L = 120,5 mm Ø= 48 mm Pressure range: 200 – 600 bar Rate of flow: 250 l/min Connections: DN 10, DN 12 or DN 19</p>
		<p>Pressure relief valve DBV 500</p> <p>Dimensions*: L = 120,5 mm Ø= 58 mm Pressure range: 200 – 600 bar Rate of flow: 500 l/min Connections: DN 12, DN 19, DN 25 or DN 19/25</p>
		<p>Pressure relief valve 1000I-N2 DN 19/25 nitrogen, unfilled</p> <p>Dimensions*: L = 172 mm Ø = 50 mm Pressure range: 500 bar Rate of flow: 1000 l/min Connections: DN 19/25</p>
		<p>Rapid yield valve</p> <p>Dimensions*: L = 252 mm Ø= 55 mm Pressure range: 300 – 600 bar Rate of flow: 1350 l/min or 2600 l/min Connections: M 40 x 2</p>
		<p>Spring-loaded safety valve in angle form with lifting lever</p> <p>Dimensions*: L = 320 mm Ø = max. 100 mm Pressure range: 0,5 – 25 bar Rate of flow: 1200 l/min Connections: Inlet coupling DN 32, outlet coupling DN 51 The valve will be delivered factory set.</p>

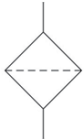

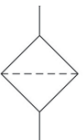
Valve technology / In-line filter

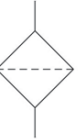

		<p>In-line filter DN 10</p> <p>Dimensions*: L = 132 mm Ø = 40 mm Test pressure: 600 bar Nominal pressure: 400 bar Filter fineness: 25µm, 40 µm, 80 µm, other filter ratings on request Connections: DN 10</p>
		<p>In-line filter DN 19</p> <p>Dimensions*: L = 124 mm Ø = 45mm Test pressure: 600 bar Nominal pressure: 400 bar Filter fineness: 25 µm and 40 µm, other filter ratings on request Connections: DN 19</p>
		<p>In-line filter DN 25</p> <p>Dimensions*: L = 222 mm Ø = 65 mm Test pressure: 600 bar Nominal pressure: 400 bar Filter fineness: 25 µm and 40 µm, other filter ratings on request Connections: DN 25</p>

*Changes of construction modifications remain open

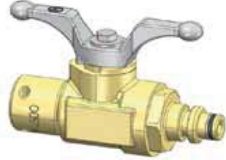
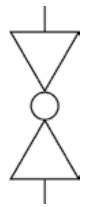
Valve technology / Ball valve DN 10 - DN 51 SSO

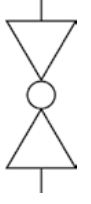
		<p>Ball valve with butterfly handle DN 10 - DN 51 SSO</p> <p>Pressure range: up to 500 bar depending on the design</p> <p>Picture example: connection DN 10</p>
		<p>Ball valve DN 10 - DN 51 SSO with locking handle</p> <p>Pressure range: up to 500 bar depending on the design</p> <p>Picture example: connection DN 19</p>

Bottom valves

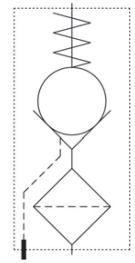
		<p>Bottom valve with filter</p> <p>Dimensions: depending on requirements of hydraulic cylinder</p> <p>Opening pressure: depending on the design</p> <p>Rate of flow: up to 500 l/min</p>
--	--	--

Pressure sensors

	<p>Pressure sensor DT600MS</p> <p>Dimensions: L = 126mm Ø = 32 mm Pressure range: 0 ... 10 bar 0 ... 450 bar 0 ... 500 bar 0 ... 600 bar, others on request Output signal: 0,5 ... 4,5 V Hydraulic connection: DN10 Electrical connection: Skk 24 coupling</p>
---	---

Mobile hydraulic testing bench

The mobile hydraulic testing bench is for manufacturer and user of hydraulic valves and components a cost-effective and very efficient solution for testing of almost all types of water hydraulic valves. This testing bench has a very compact construction.

The testing bench stands on 4 castors, which allow to move it anytime without any strain. If needed, the testing bench can be parted very easy, so it can be transported, for example, through a doorway.

The testing bench allows to implement a wide range of different tests in a small space. For example, it allows to test electro-hydraulic control units with up to 24 functions, peripheral valves, solenoid valves, safety valves in different pressure stages. To the standard program for testing of solenoid valves belongs the presentation of the current reduction and the coil resistance.

All functions and control commands of the testing bench are implemented solely with mouse and key board. A troublesome manual operating with valves is omitted.

The check programs for pilot controls, electro-hydraulic controls, peripheral valves and solenoid valves are controlled manually.

The testing of the safety valves is implemented automatically. After positive testing the program generates a report, which contains all important informations of the test.

At the request of the user all check programs can be programmed in automatic run. This option is not a part of standard scope of delivery and supposed to be ordered separately.

The menu navigation of the testing bench allows also unpractised persons to work trouble-free with the testing bench in a minimum of time.

An easy to operate protective cap, which is held by a gas-filled shock absorber, protects the user during almost all testing processes against escaping hydraulic fluid.

The emergency stop system of the testing bench is very well engineered, so that any injuries are almost excluded. By activation of the kill switch all control valves and the pump are immediately deactivated. An ongoing escape of hydraulic fluids is excluded. The emergency-stop function has to be reset via double acknowledgement.

The core of the testing bench is an efficient and compact plunger pump with volumetric delivery 5 liters/min.

It feeds the system steady with pressure. A 5 liters hydropneumatic accumulator supports the pump

and avoids large pressure variations and pressure shocks in the hydraulic system.

Following pressure outputs are available for the testing of different valves and control units:

P1 elective: 35 bar, 125 bar, 300 bar or variable pressure from 125 up to 600 bar.

P2 elective: 35 bar, 125 bar or 300 bar.

P3 and P4 300 bar each one.

During the testing of control units additionally the return flow has to be locked. This function allows the tester to check the tightness of the return flow channels.

For checking of the functionality of pilot control units and electro-hydraulic control units 24 inputs for pressure sensors are available, which optically present the through switching of the 3/2 way valve cartridges.

For activation of the solenoid valves of electro-hydraulic control units are available 24 valve outputs. The function „open leakage line“ allows the tester to make the leakiness of a control unit optically visible. This function can be used if simultaneously several valves in a control block are leaky.

All the necessary pressure indications are digitally displayed. That allows a very precise pressure indication in 1 bar steps. Hereby the least leakiness of the test piece is immediately visible

Technical data:

Supply voltage:

400 Volt- 50 Hz

Power consumption of the pump: 4000 Watt

Power consumption of the control unit: 1000 Watt max.

Volumetric delivery of the pump: 5 L / min.

System pressure: 320 bar

Max. test pressure: 600 bar

Measurements of the testing bench:

height: 195 cm, width: 140 cm, length: 120 cm

